

Article number: 20992D32M8

Description: E+G Threaded end-caps - GN 992-D32-M8

Measures

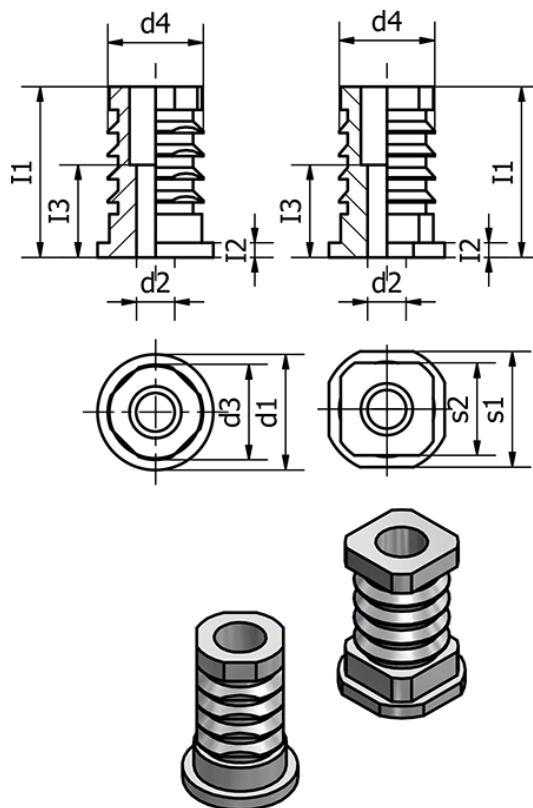

d1 = D32

d2 = 8

d3 = 28

d4 = 28.5

I1 = 33.5

I2 = 2.5

I3 = 18

s1 =

s2 =

Weight (g) = 50